

BULB NOT INCLUDED

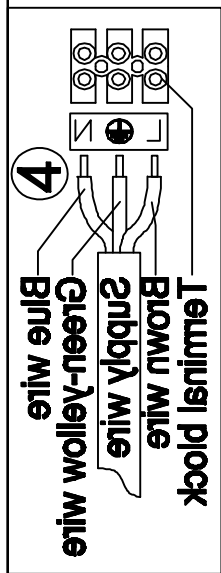
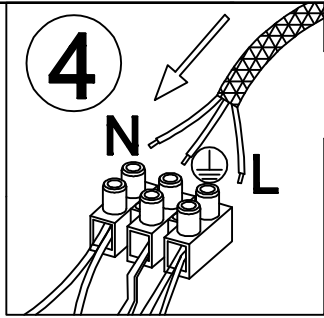
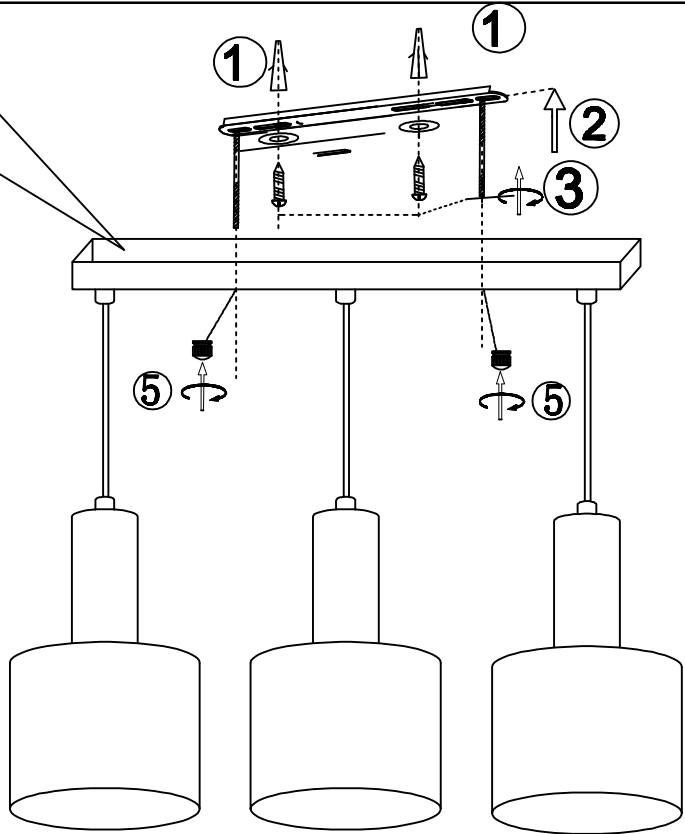

33-21311