

BULB NOT INCLUDED

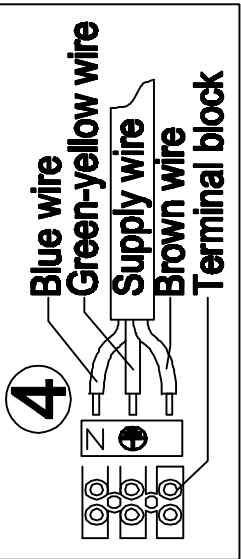
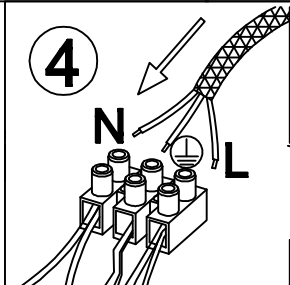
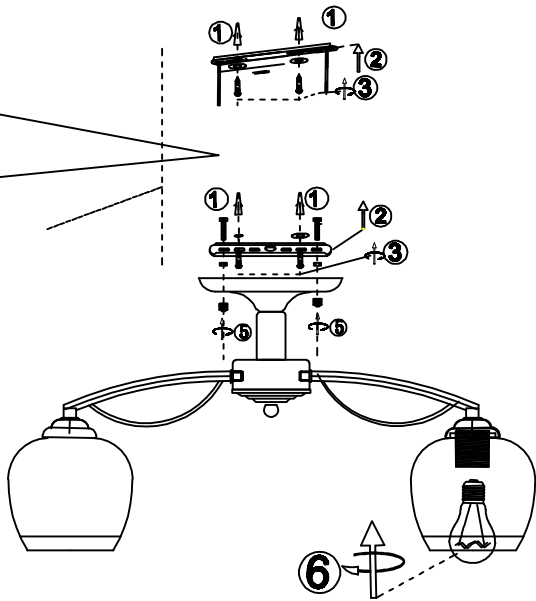

35-22721