









Fig.1

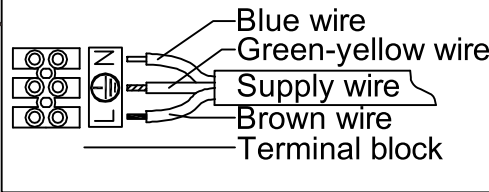
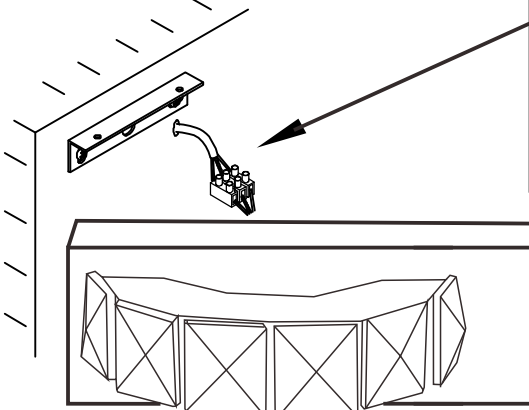
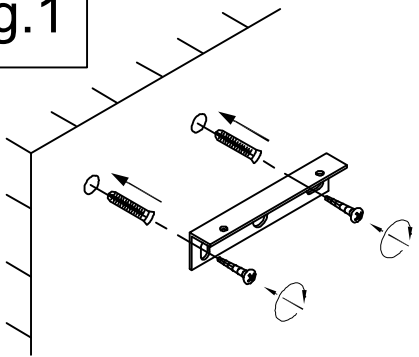

Fig.2

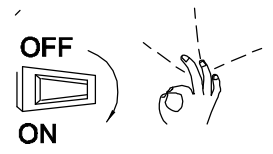
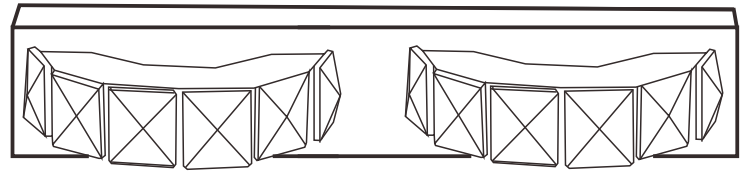
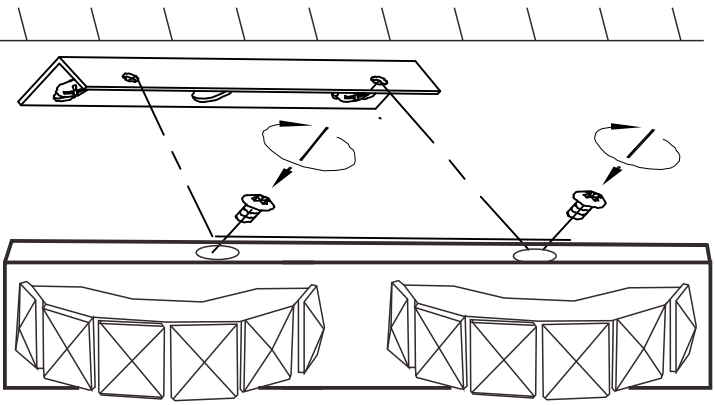

Fig.3

22-45300

Fig.4